

ALWAYS
THE BEST
**PROTECTION
PROFILES**





PRESENTS NEW MATERIAL





CONTENTS



page 02

01	Rack Protections	page 08	06	Link	page 38
02	Bollards	page 16	07	Column Protections	page 46
03	Guard Rails	page 20	08	Corner Protections	page 52
04	Pedestrian Safety Barriers	page 26	09	Kerb	page 54
05	Doors	page 32	10	Wall Bumpers	page 58
			11	PVC Panel	page 64

OUR PENDULUM MACHINE FOR CRASH REPORTS





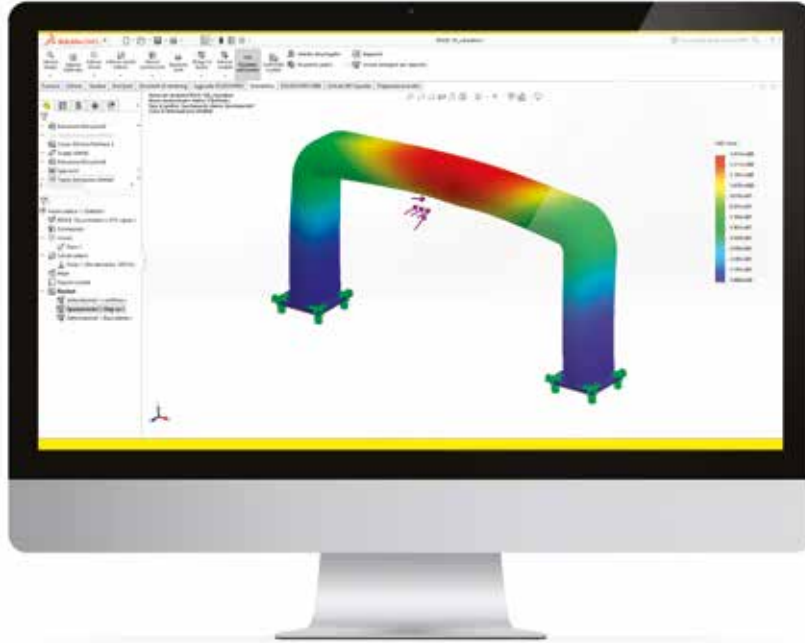

RESEARCH AND DEVELOPMENT

CUSTOMISED PROJECT MANAGEMENT SERVICE



FOR PVC FLEXIBLE BARRIER

PVC PROTECTION ARE THE BEST CHOICE IN COMPARISON TO METAL OR OTHER MATERIALS

		METAL	PE/PP	WOOD
				
EASY CLEANING	● ● ● ● ●	● ● ● ● ○	● ● ○ ○ ○	○ ○ ○ ○ ○
SCRATCHES	● ● ● ● ●	● ● ● ○ ○	● ● ● ○ ○	● ○ ○ ○ ○
FLEXIBILITY	● ● ● ● ●	● ○ ○ ○ ○	● ● ● ● ●	● ● ○ ○ ○
SHOCK ABSORBER	● ● ● ● ●	○ ○ ○ ○ ○	● ● ● ● ○	● ● ○ ○ ○
FAST INSTALLATION	● ● ● ● ●	● ● ● ● ●	● ● ● ○ ○	● ● ● ● ○
SAVE SPACE	● ● ● ● ○	● ● ● ● ●	● ● ○ ○ ○	● ● ● ○ ○
FIRE RESISTANT	● ● ● ● ○	● ● ● ● ●	○ ○ ○ ○ ○	○ ○ ○ ○ ○
LONG LASTING	● ● ● ● ●	● ● ● ● ●	● ● ● ○ ○	● ● ○ ○ ○

NEW!

DO IT YOURSELF!

GENIUS

THE LENGTH THAT YOU WISH

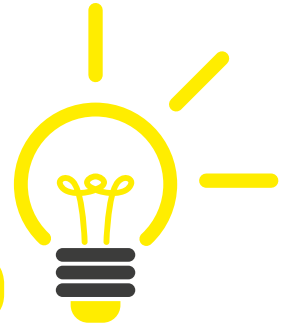

FOR YOUR
PEDESTRIAN
BARRIERS

FOR YOUR
HUG TOWER

WORLD'S UNIQUE SYSTEM!

ADAPT THE LENGTH OF HORIZONTAL RAILS UP TO YOUR NEEDS

CUT THE RAIL AND DRILL IT WITH GENIUS 

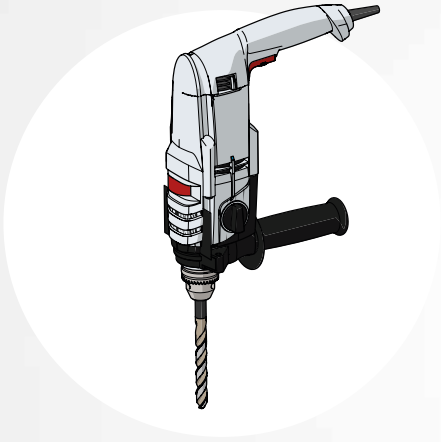

HERE YOU ARE!

YOUR CUSTOMIZED BARRIER AND HUG TOWER!

01

RACK PROTECTIONS

OUR PROFILES FIT ALL RACKS



**HIGH
IMPACT
ABSORPTION**

Full range of techno polymer profiles for protection of warehouse racks.

Gamma completa di profili in tecnopolimeri per la protezioni di scaffali.

Complète gamme de profilés en tecnopolimère pour la protection d'étagères de dépôts.

Gama completa de perfiles de tecnopolímeros para las protecciones de estanterías.





EASY TO INSTALL

THE ONLY ONE WITH TRIPLE SHOCK ABSORBER

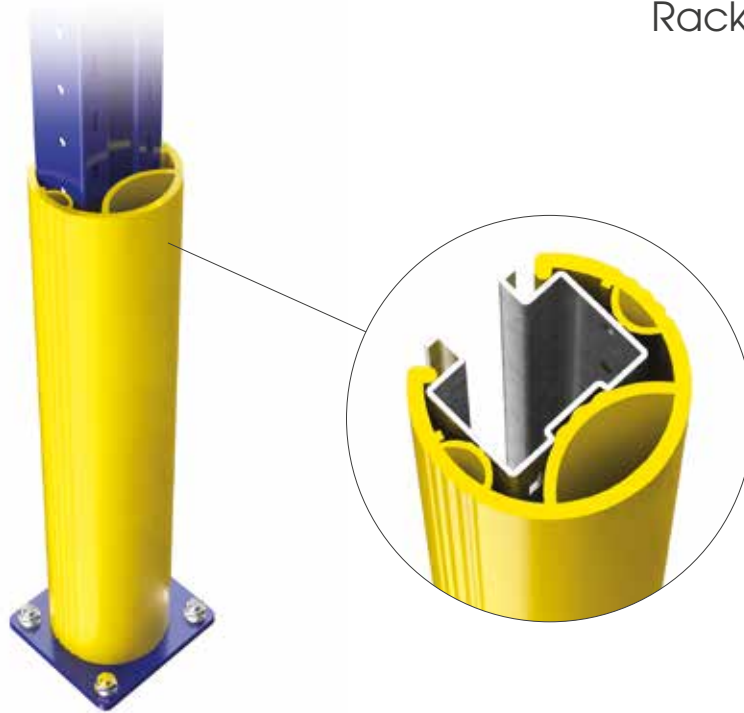

RPS 600

60 80

ANTISHOCK MATERIAL INSIDE

Packing 6 pz / box
Packing 114 pz / big parcel
Colour M

Available also size 400

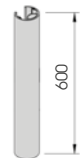

RPM 600

80 100

ANTISHOCK MATERIAL INSIDE

Packing 4 pz / box
Packing 80 pz / big parcel
Colour M

Available also size 400

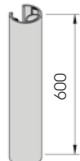

RPL 600

100 120

ANTISHOCK MATERIAL INSIDE

Packing 2 pz / box
Packing 54 pz / big parcel
Colour M

Available also size 400

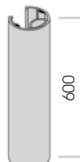

RPL XL 600

100 120

ANTISHOCK MATERIAL INSIDE

Packing to be defined
Colour M

Available also size 400



RP CLICK

Packing 1 pz / box

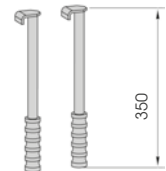

RPF 600

60 130

FLEXIBLE

Packing 2 pz / bag
Colour C

Axle spacing 25 - 50 - 75 mm

Equipped with accessories

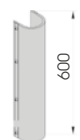

Rack end Barriers

SM



DIFFERENT SIZES ON REQUEST

FAST AND EASY TO INSTALL



SM 1500x400 MODULAR

Packing Colour **unpacked on pallet**
 B M

Equipped with accessories

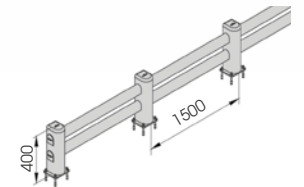

SM 1100x400

Length Packing Colour **unpacked on pallet**
 B M

Equipped with accessories

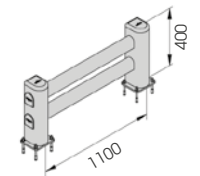

LM



DIFFERENT SIZES ON REQUEST

FAST AND EASY TO INSTALL



M12 GALVANISED STEEL



LM 2000x500 MODULAR

Packing Colour **unpacked on pallet**
 B M

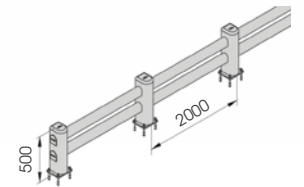

Equipped with accessories



**LM 1100x500
LM 2400x500**

Length Packing Colour **unpacked on pallet**
 B M

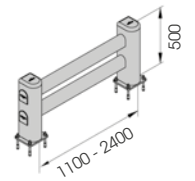

Equipped with accessories



Rack end Barriers

FENCE 90



DIFFERENT
SIZES ON
REQUEST

FAST
AND EASY
TO INSTALL



**M12
GALVANISED STEEL**



FE 90 1100x350

Length **1.100 mm**
Packing **unpacked on pallet**
Colour **B M**

Equipped with accessories

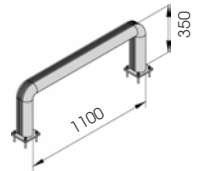

FE 90 2400x350

Length **2.400 mm**
Packing **unpacked on pallet**
Colour **B M**

Equipped with accessories



FENCE 150



DIFFERENT SIZES ON REQUEST

FAST AND EASY TO INSTALL



M12 GALVANISED STEEL



FE 150 1100x550

Length **1.100 mm**
Packing **unpacked on pallet**
Colour **B M**

Equipped with accessories



FE 150 2400x550

Length **2.400 mm**
Packing **unpacked on pallet**
Colour **B M**

Equipped with accessories



FENCE 150 REINFORCED



DIFFERENT SIZES ON REQUEST

FAST AND EASY TO INSTALL



M12 GALVANISED STEEL



FE 150 REF 1100x550

Length **1.100 mm**
 Packing **unpacked on pallet**
 Colour **B M**

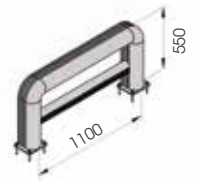

Equipped with accessories



FE 150 REF 2400x550

Length **2.400 mm**
 Packing **unpacked on pallet**
 Colour **B M**



Equipped with accessories



FENCE LINK



DIFFERENT SIZES ON REQUEST

FAST AND EASY TO INSTALL



M12 GALVANISED STEEL



FE LINK 1100x550

Length 1.100 mm
Packing unpacked on pallet
Colour B M

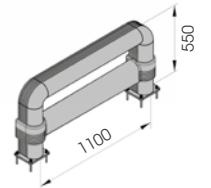

Equipped with accessories

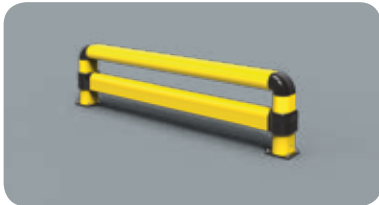

FE LINK 2400x550

Length 2.400 mm
Packing unpacked on pallet
Colour B M

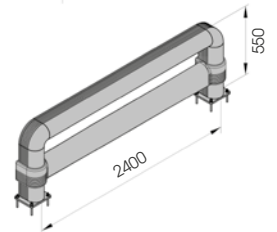

Equipped with accessories



02

BOLLARD

Designed to protect access to gates or big doors from huge traffic or simply to mark restricted areas for pedestrians. Fully equipped with fixing accessories.

In addition to guard rail system, please check page 20
A completamento della linea guard rail, vedi pag. 20
Pour compléter la gamme guard rail, voir la page 20
Para completar la línea de barandilla, ver la página 20



Ideato per proteggere l'accesso a cancelli o portoni dalla movimentazione di mezzi pesanti o semplicemente per impedire l'ingresso di pedoni. Provvisto di accessori di fissaggio.

Etudié pour protéger l'accès aux portes ou entrées de grand trafic ou simplement pour marquer les zones de passage piétons. Equipé avec les accessoires d'installation.

Diseñado para proteger el acceso a puertas o portones del movimiento de vehículos pesados o simplemente para evitar la entrada de peatones. Provisto de accesorios de fijación.



ROD



RE
EASY TO
REMOVE AND
TO REPLACE



GALVANISED STEEL

Fixing accessory available also in stainless steel



ROD PE 70 266 RE

Packing
Colour **6 pz / box**
C



Drill Ø 38
Equipped with accessories

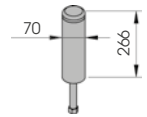

**ROD PE 120 433 RE
560 RE**

Packing
Colour **1 pz / bag**
M



Drill Ø 56
Equipped with accessories

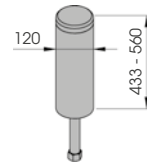

GRD



FAST AND EASY TO INSTALL



M12 GALVANISED STEEL



GRD 90 250



Equipped with accessories

Packing Colour **unpacked on pallet**
 B M

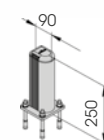

GRD 150 * 500
800
1150



Equipped with accessories

Packing Colour **unpacked on pallet**
 B M

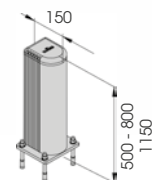

03

GUARD RAILS

A new bumper system specific for the protection of the walls resistant against trolleys movements. Designed by following an innovative technical design that combines speed and simplicity in the steps of installation and cleaning. Available in different lengths.

Sistema profili antiurto specifico per la protezione delle pareti dai carrelli in movimento. Progettato seguendo un innovativo disegno tecnico che coniuga rapidità e semplicità nelle fasi di installazione e pulizia. Disponibile in diverse lunghezze.

Nouveau système bumper, spécifique pour protéger les murs contre les mouvements des charriots. Étudié avec un modern dessin qui regroupe la rapidité et la facilité pendant l'installation et le nettoyage. Disponible en différents longueurs.

Sistema de perfiles anti-impacto específico para la protección de las paredes de los carros en movimiento. Diseñado según un diseño técnico innovador que une velocidad y simplicidad en las fases de instalación y limpieza. Disponible en diferentes longitudes.



TRUCK LINE



DIFFERENT SIZES ON REQUEST



M20
STAINLESS STEEL



TL	500	2000
	750	3000
	1000	4000
	1500	

Equipped with accessories

Packing Colour to be defined

B M

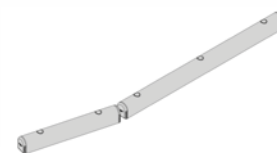

Guard Rails

GUARD RAIL 90



**QUICK
INSTALLATION
WITH
EXPANSION
SCREW**



**M16
GALVANISED STEEL**



ALTERNATIVE FIXING
HIGH RESISTANCE WITH RESIN

**M16
STAINLESS STEEL**



GR 90 500
750
1000
1500

Length 500 mm
Packing 4 pz / box

Length 750 / 1000 / 1500 mm
Packing 2 pz / box

Colour B M

Equipped with accessories

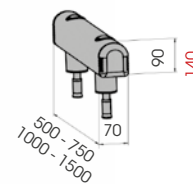

GR 90 2000
3000
4000

Length 2.000 / 3.000 / 4.000 mm
Packing 2 pz / box
Colour B M

Equipped with accessories

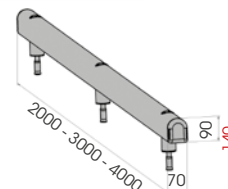

GUARD RAIL 150



**M20
STAINLESS STEEL**

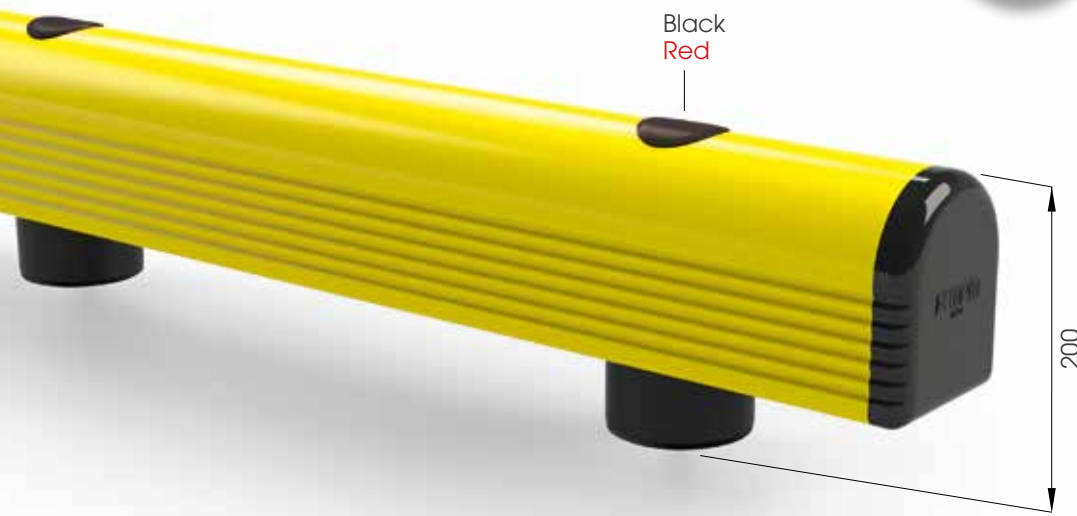

GR 150 500
750
1000
1500

Length 500 / 750 / 1000 / 1500 mm
Packing unpacked on pallet
Colour B M

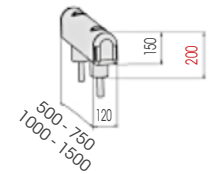

Equipped with accessories



GR 150 2000
3000
4000

Length 2.000 / 3.000 / 4.000 mm
Packing unpacked on pallet
Colour B M

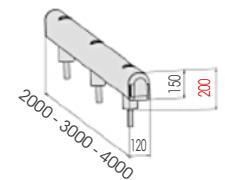

Equipped with accessories



Guard Rails

GRIN 90

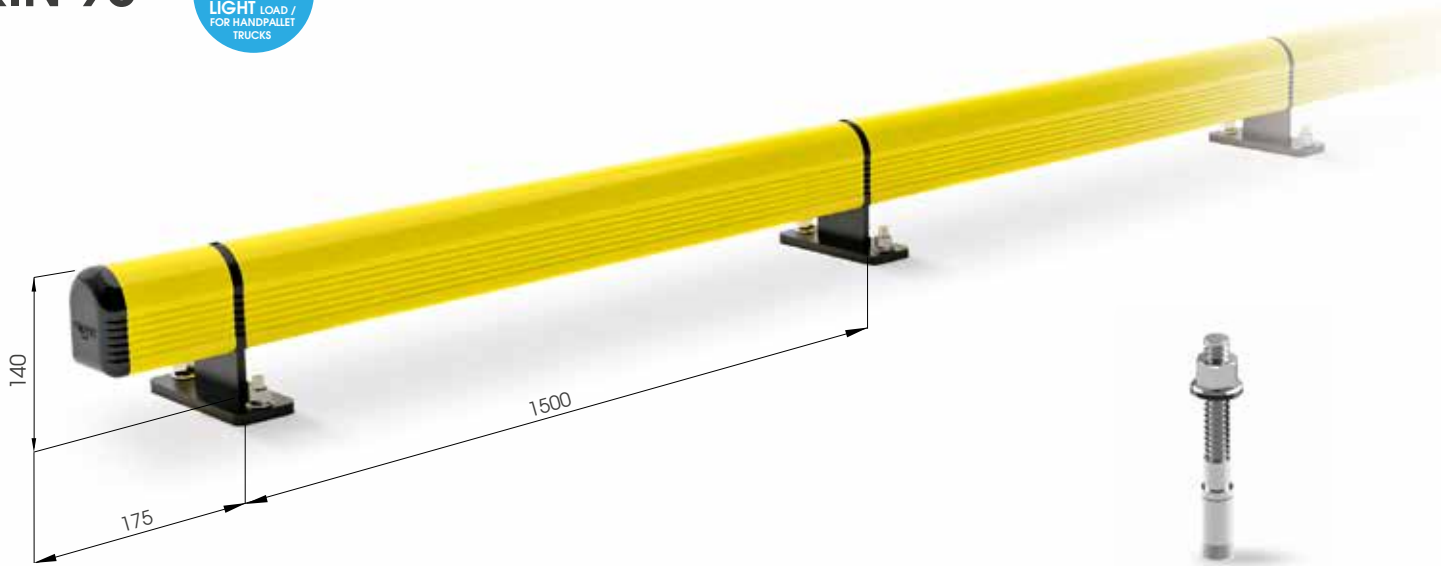

**M12
GALVANISED STEEL**



GRIN 90 1500

Length **1500 mm**
Packing **to be defined**
Colour **M**

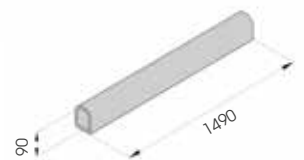

GRINCO 90

Packing **to be defined**
Colour **M**

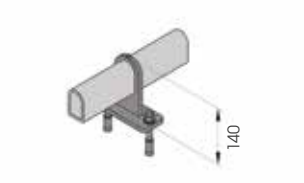

Equipped with accessories



GRINT 90

Packing **to be defined**
Colour **M**

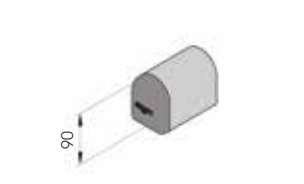

Equipped with accessories



GRIN 150



**M12
GALVANISED STEEL**



GRIN 150 2000

Length **2000 mm**
Packing **to be defined**
Colour **M**

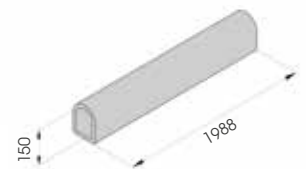

GRINCO 150

Packing **to be defined**
Colour **M**

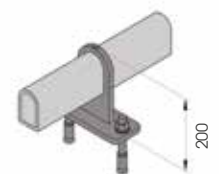

Equipped with accessories



GRINT 150

Packing **to be defined**
Colour **M**

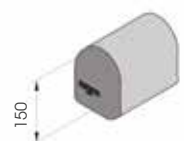

Equipped with accessories



04

PEDESTRIAN SAFETY BARRIERS



A new protection system specific for the protection of pedestrians and resistant to trolleys movements with different load types. Designed by following an innovative technical design that combines speed and simplicity in the steps of installation and cleaning. Available in different lengths.

Sistema di profili antiurto specifico per la protezione delle aree pedonali dai carrelli in movimento con diverse portate di carico. Progettato seguendo un innovativo disegno tecnico che coniuga rapidità e semplicità nelle fasi di installazione e pulizia. Disponibile in diverse lunghezze.

Nouveau système bumper, spécifique pour protéger les zones piétonnes contre les mouvements des charriots. Étudié avec un modern dessin qui regroupe la rapidité et la facilité pendant l'installation et le nettoyage. Disponible en différents longueurs.

Sistema específico de perfiles antichoque para la protección de zonas peatonales de carros en movimiento con diferentes capacidades de carga. Diseñado según un diseño técnico innovador que une velocidad y simplicidad en las fases de instalación y limpieza. Disponible en diferentes longitudes.



HAND RAIL 90



FAST AND EASY TO INSTALL

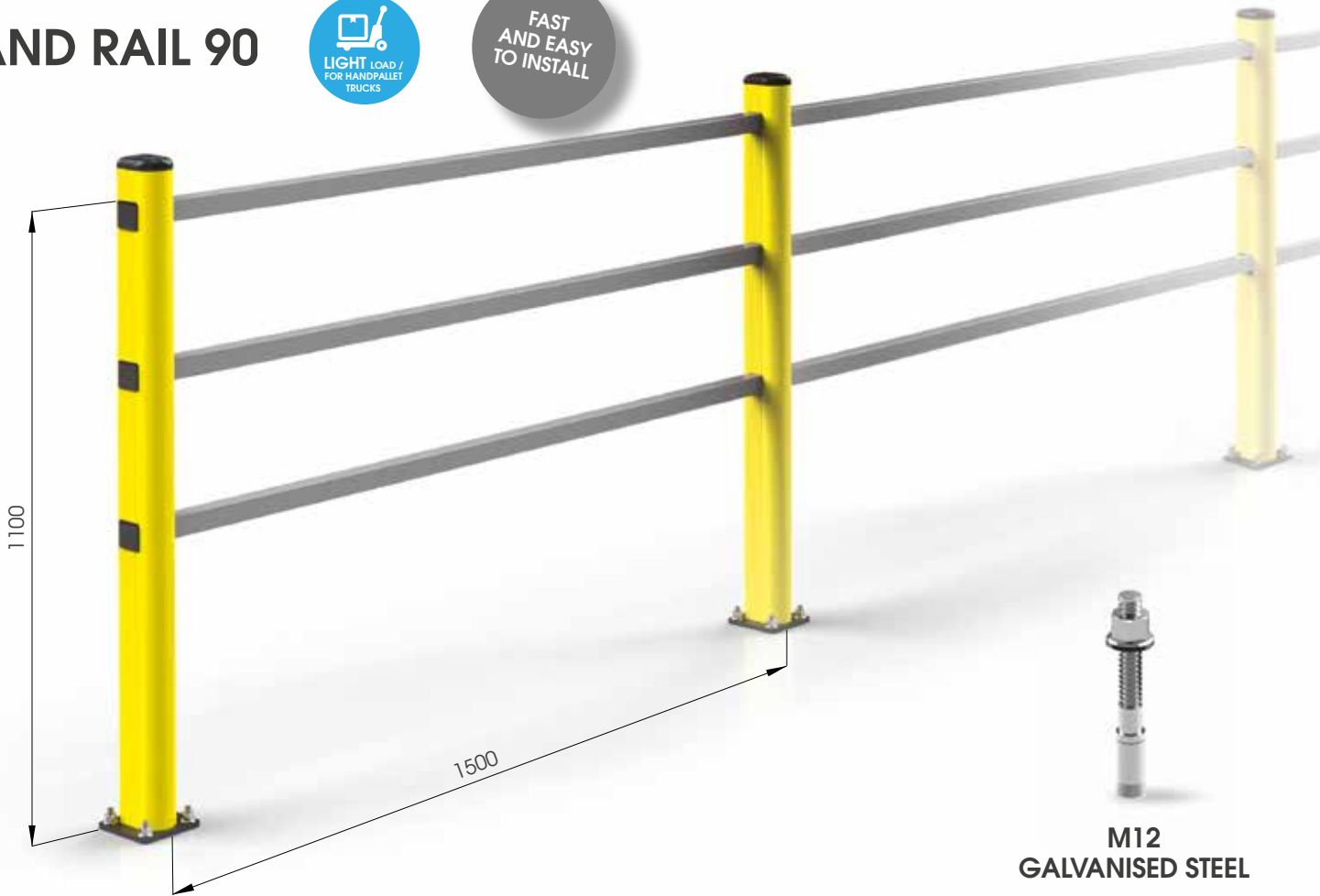

M12 GALVANISED STEEL

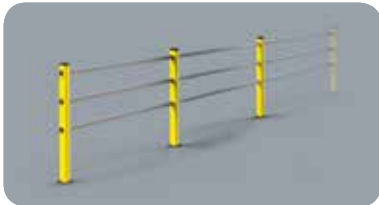

HR 90 1500x1150 MODULAR

Packing Colour **unpacked on pallet**
M

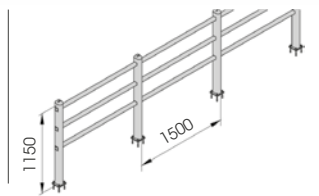

Equipped with accessories

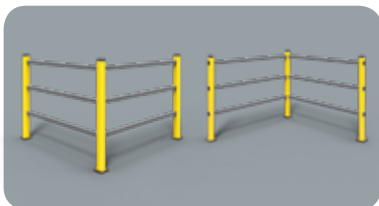

HR 90 1500x1150 CORNER

Packing Colour **unpacked on pallet**
M

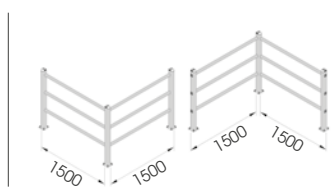

Equipped with accessories



PEDESTRIAN 90



**FAST
AND EASY
TO INSTALL**



**M12
GALVANISED STEEL**



**PED 90 1500x1150
MODULAR**

Packing Colour **unpacked on pallet**
 B M

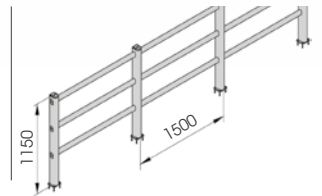

Equipped with accessories

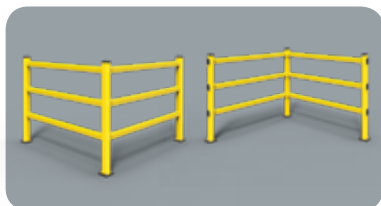

**PED 90 1500x1150
CORNER**

Packing Colour **unpacked on pallet**
 B M

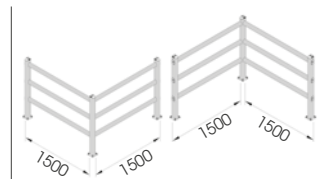

Equipped with accessories



PEDESTRIAN 150



FAST AND EASY TO INSTALL



M12 GALVANISED STEEL



PED 150 2000x1150 MODULAR

Packing Colour **unpacked on pallet**
 B M

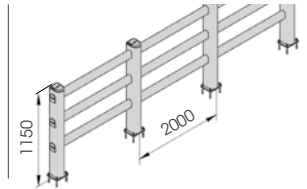

Equipped with accessories

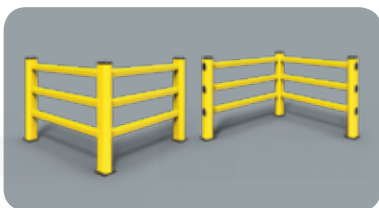

PED 150 2000x1150 CORNER

Packing Colour **unpacked on pallet**
 B M

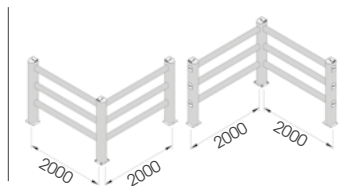

Equipped with accessories



PEDESTRIAN 90 REINFORCED



M12 GALVANISED STEEL



PED 90 REF MODULAR

Packing Colour **unpacked on pallet**
B M

Equipped with accessories

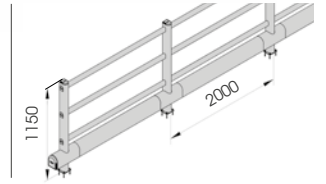

PEDESTRIAN 150 REINFORCED LINK



FAST
AND EASY
TO INSTALL



M12
GALVANISED STEEL



PED 150 REF LINK

Packing Colour **unpacked on pallet**
B M

Equipped with accessories

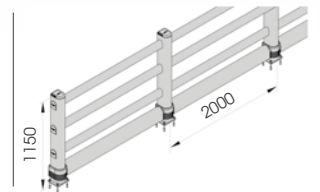

05

DOORS

Safety gate system with different opening possibilities, ideated to be installed on our pedestrian barriers. Designed by following an innovative technical design that combines speed and simplicity in the steps of installation and cleaning. Available in different opening systems.

Sistema di cancelli antiurto ideati per l'installazione nelle nostre barriere di protezione per aree pedonali. Progettati seguendo un innovativo disegno tecnico che coniuga rapidità e semplicità nelle fasi di installazione e pulizia. Disponibili molteplici sistemi di apertura.

Système de portillons résistant aux chocs étudié pour l'installation de nos barrières de protections pour les zones piétons. Portillons conçus suivant un design innovant qui combine rapidité et simplicité pendant le montage et le nettoyage. Différents systèmes d'ouvertures disponibles.

Sistema de puertas antigolpe diseñadas para la instalación de nuestras barreras de protección para áreas peatonales. Diseñado según un diseño técnico innovador que une velocidad y simplicidad en las fases de instalación y limpieza. Están disponibles varios sistemas de apertura.



Full frame

FULL FRAME



DIFFERENT SIZES ON REQUEST

FAST AND EASY TO INSTALL

OPTION:
WALL FIXING ACCESSORIES

NEW
BIGGER PLATES!



M16
STAINLESS STEEL



DOOR PEDESTRIAN 90

DIFFERENT SIZES ON REQUEST



DP 90 ONE WAY

Packing Colour **to be defined**
 Colour **M**

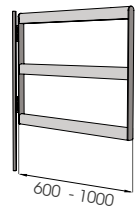

Equipped with accessories



DP 90 SWING

Packing Colour **to be defined**
 Colour **M**

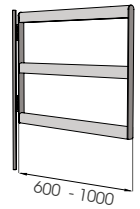

Equipped with accessories

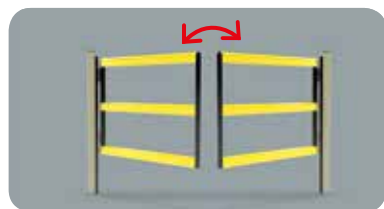

DP 90 SWING DOUBLE

Packing Colour **to be defined**
 Colour **M**

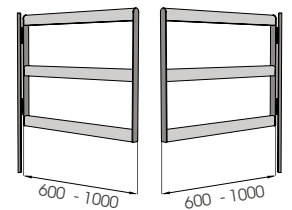

Equipped with accessories



DOOR PEDESTRIAN 150

DIFFERENT SIZES ON REQUEST

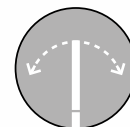

NEW SWING OPENING



MIN 600 MAX 1000



DP 150 ONE WAY

Packing Colour **to be defined**
 Colour **M**

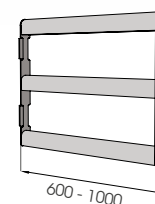

Equipped with accessories



DP 150 SWING

Packing Colour **to be defined**
 Colour **M**

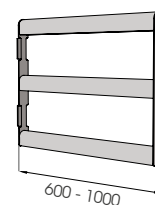

Equipped with accessories

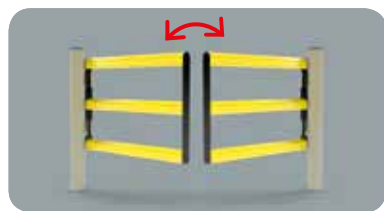

DP 150 SWING DOUBLE

Packing Colour **to be defined**
 Colour **M**

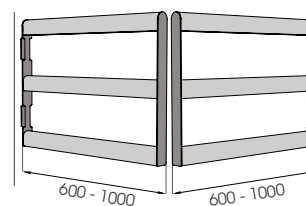

Equipped with accessories



LIFT GATE 90

DIFFERENT SIZES ON REQUEST

NEW

LIFT GATE 90 DOUBLE



DOUBLE GATE

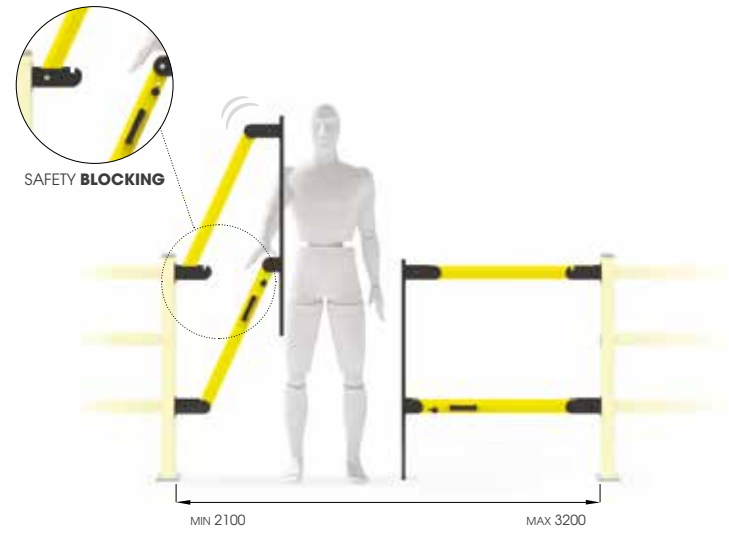
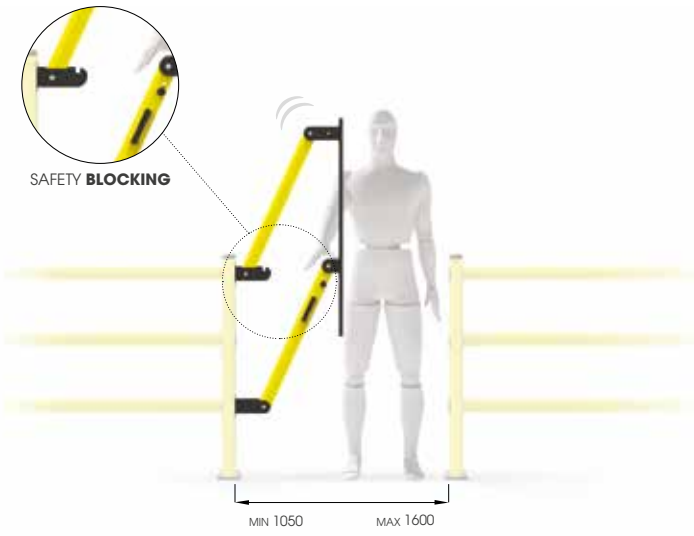

LIFT GATE 90

Packing Colour **to be defined**
M



Equipped with accessories

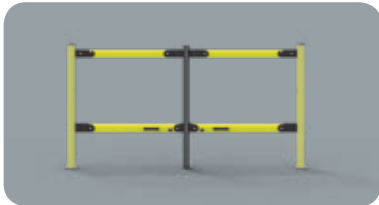

LIFT GATE 90 DOUBLE

Packing Colour **to be defined**
M

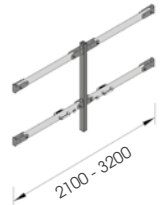

Equipped with accessories



LIFT GATE 150

DIFFERENT SIZES ON REQUEST

NEW

LIFT GATE 150 DOUBLE

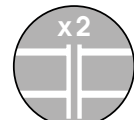

DOUBLE GATE

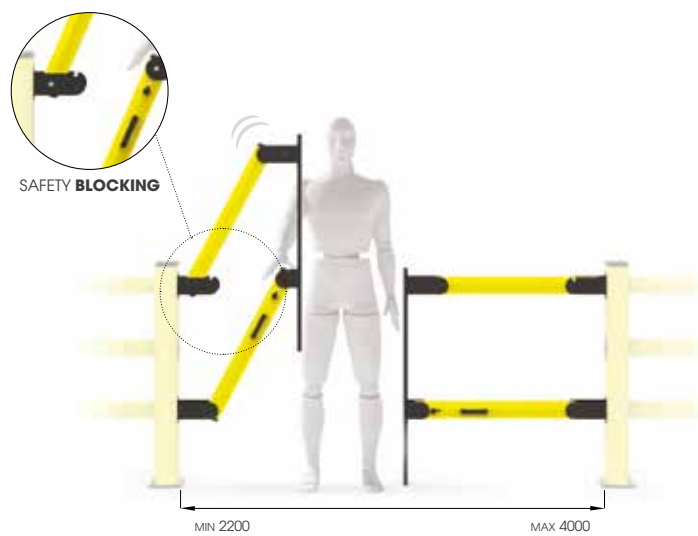
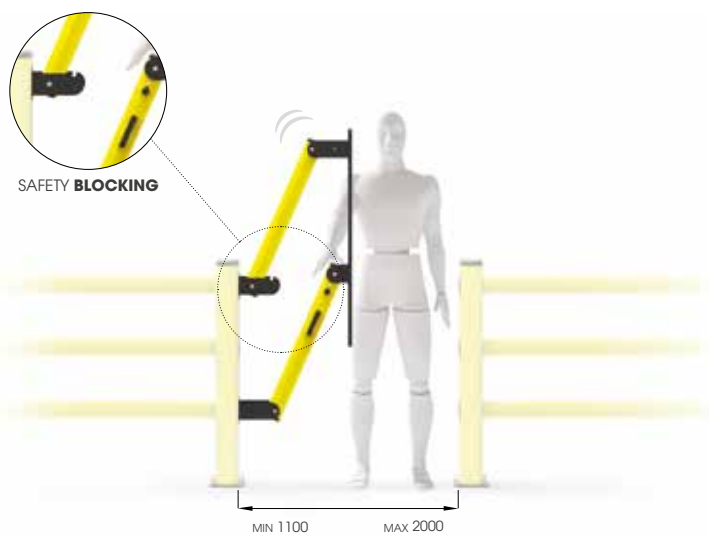

LIFT GATE 150

Packing Colour **to be defined**
M

Equipped with accessories

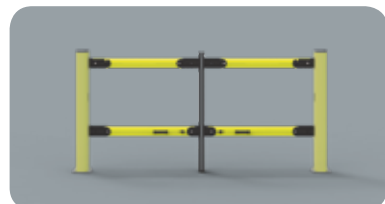
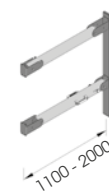

LIFT GATE 150 DOUBLE

Packing Colour **to be defined**
M

Equipped with accessories

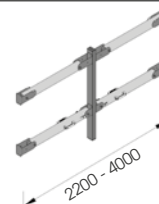

06

LINK

The first adaptable barrier in the world thanks to the new connection system. Rail adjustable height, easy to set up, higher resistance in the most critical points.

Prima barriera al mondo regolabile a piacimento con nuovo sistema di raccordo. Altezza regolabile, facilmente componibili e resistenza potenziata nei punti piu' critici.

Première barrière au monde à modifier aux besoins avec un nouveau système de jonction. Hauteur à changer, facile à assembler et résistance renforcée aux points plus compliqués.

Primera barrera del mundo ajustable según lo necesario con un nuevo sistema de ajuste. Altura ajustable, fácilmente componibles y resistencia potenciada en los puntos más críticos.

**NEW
PRODUCT**



**ADAPTABLE
HEIGHT**



**ON YOUR
NEEDS**



LINK 150/3



DIFFERENT SIZES ON REQUEST



M12 GALVANISED STEEL

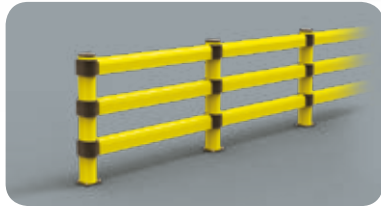

LINK 150/3

Packing Colour **unpacked on pallet**
M

Equipped with accessories

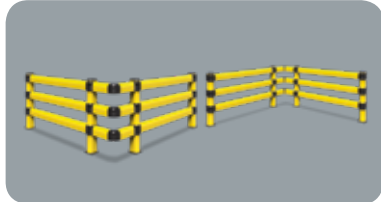
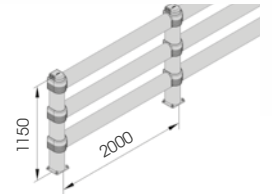

LINK 150/3 CORNER

Packing Colour **unpacked on pallet**
M

Equipped with accessories

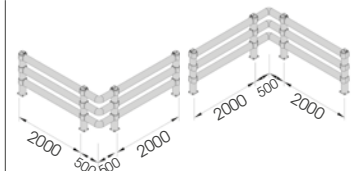

Link

LINK 150/2



DIFFERENT SIZES ON REQUEST

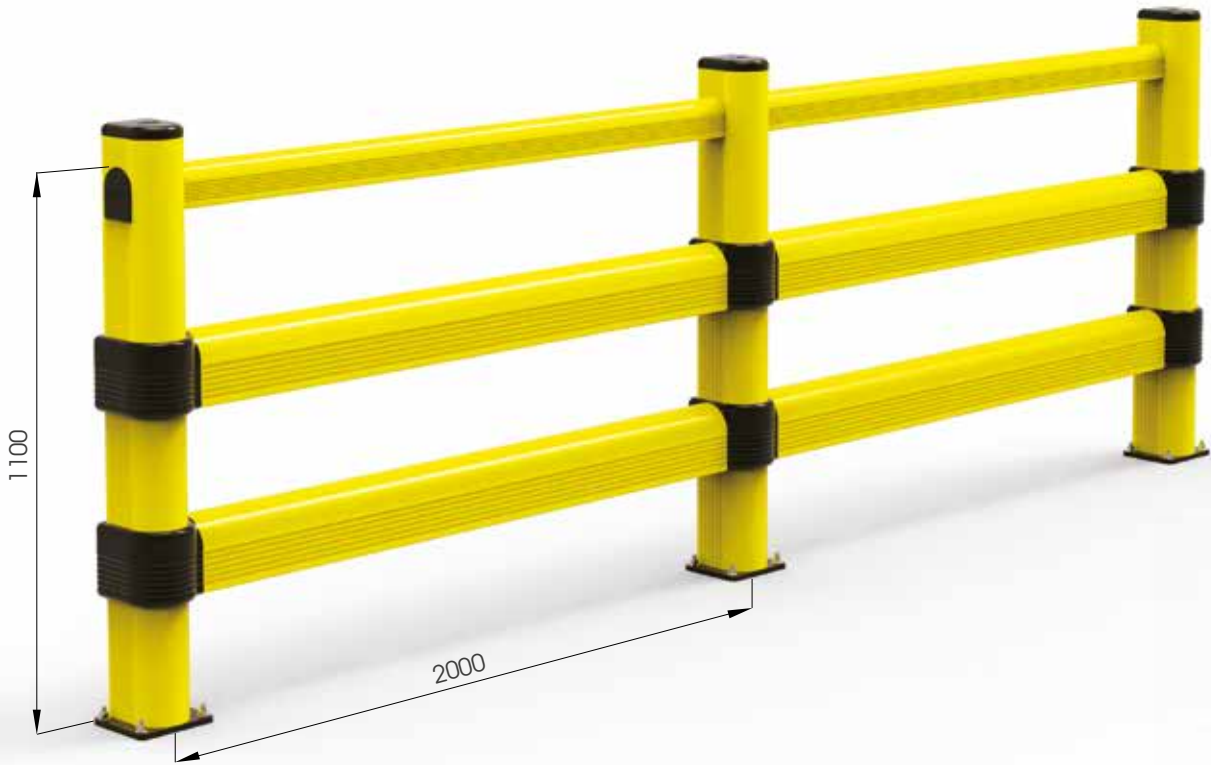

M12 GALVANISED STEEL

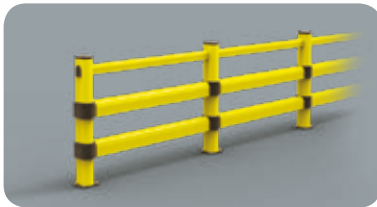

LINK 150/2

Packing **unpacked on pallet**
Colour **M**

Equipped with accessories

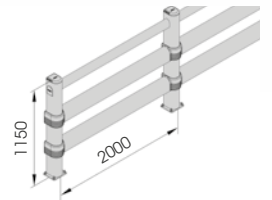

LINK 150/1



DIFFERENT SIZES ON REQUEST

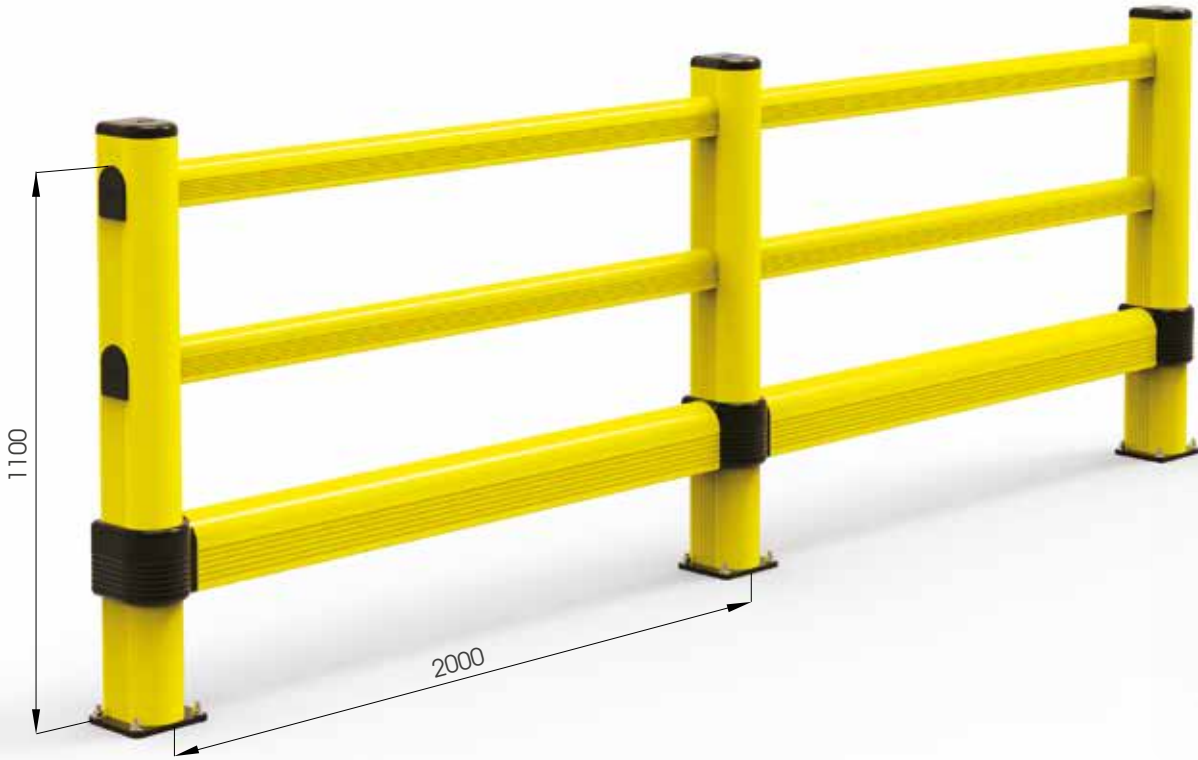

M12 GALVANISED STEEL



LINK 150/1

Packing: unpacked on pallet
Colour: M

Equipped with accessories

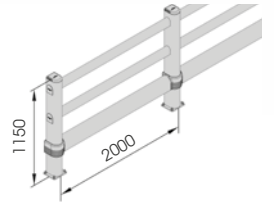

Link

LINK LM



DIFFERENT SIZES ON REQUEST

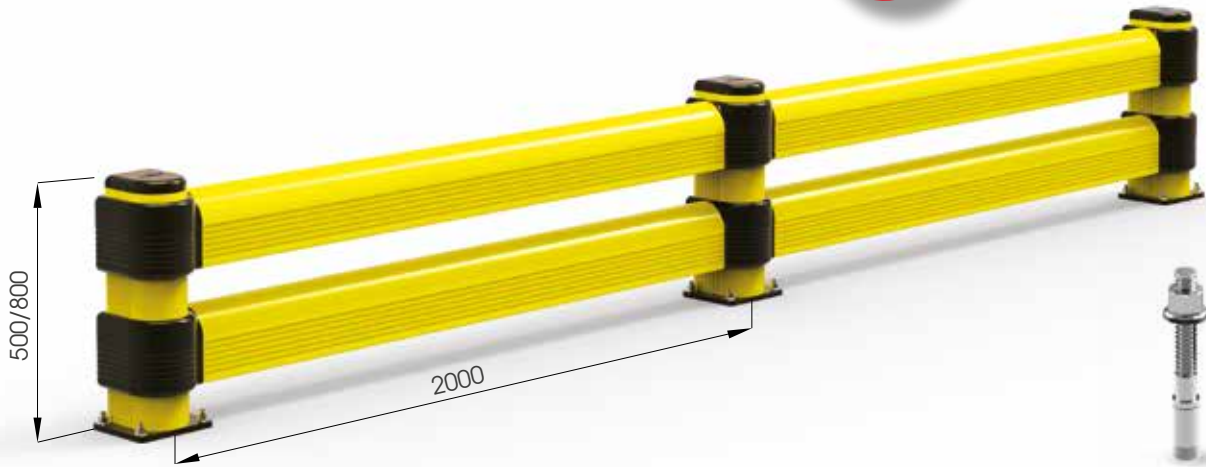

M12 GALVANISED STEEL

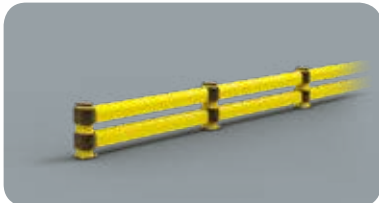

LINK LM 500/800

Packing Colour **unpacked on pallet**
Colour **M**

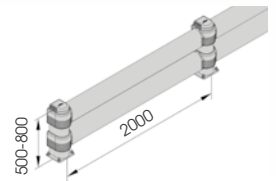

Equipped with accessories

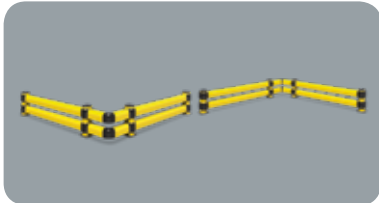

LINK LM CORNER

Packing Colour **unpacked on pallet**
Colour **M**

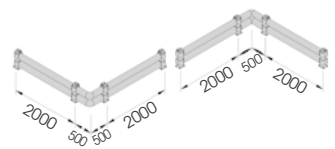

Equipped with accessories



LINK SINGLE



DIFFERENT SIZES ON REQUEST

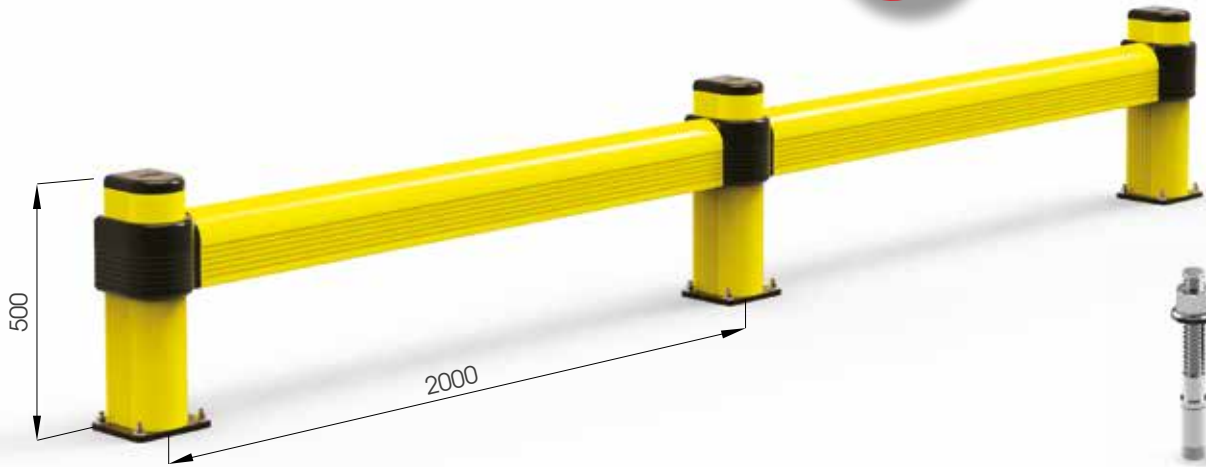

M12 GALVANISED STEEL

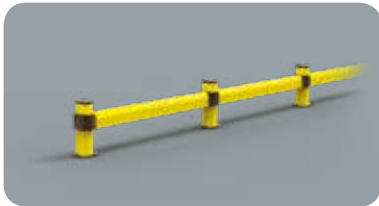

LINK SINGLE

Packing Colour **unpacked on pallet**
M

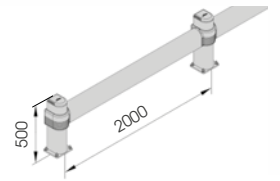

Equipped with accessories

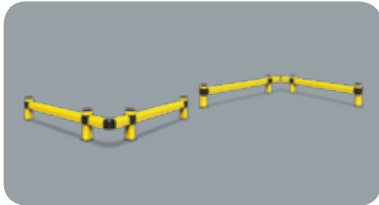

LINK SINGLE CORNER

Packing Colour **unpacked on pallet**
M

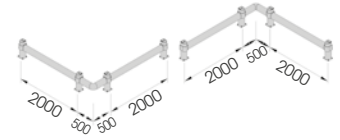

Equipped with accessories



NOW READY
NEW OPTIONS FOR
OUR **SAFETY BARRIERS**
AND **RACK PROTECTORS**



AVAILABLE FOR:
SM / LM / FENCE
HR 90 / PED 90 / PED 150



07

COLUMN PROTECTIONS

A new bumper system specific for the protection of the columns resistant against trolleys movements and for different load types. Designed by following an innovative technical design that combines speed and simplicity in the steps of installation and cleaning. Available in different heights and fixing systems.

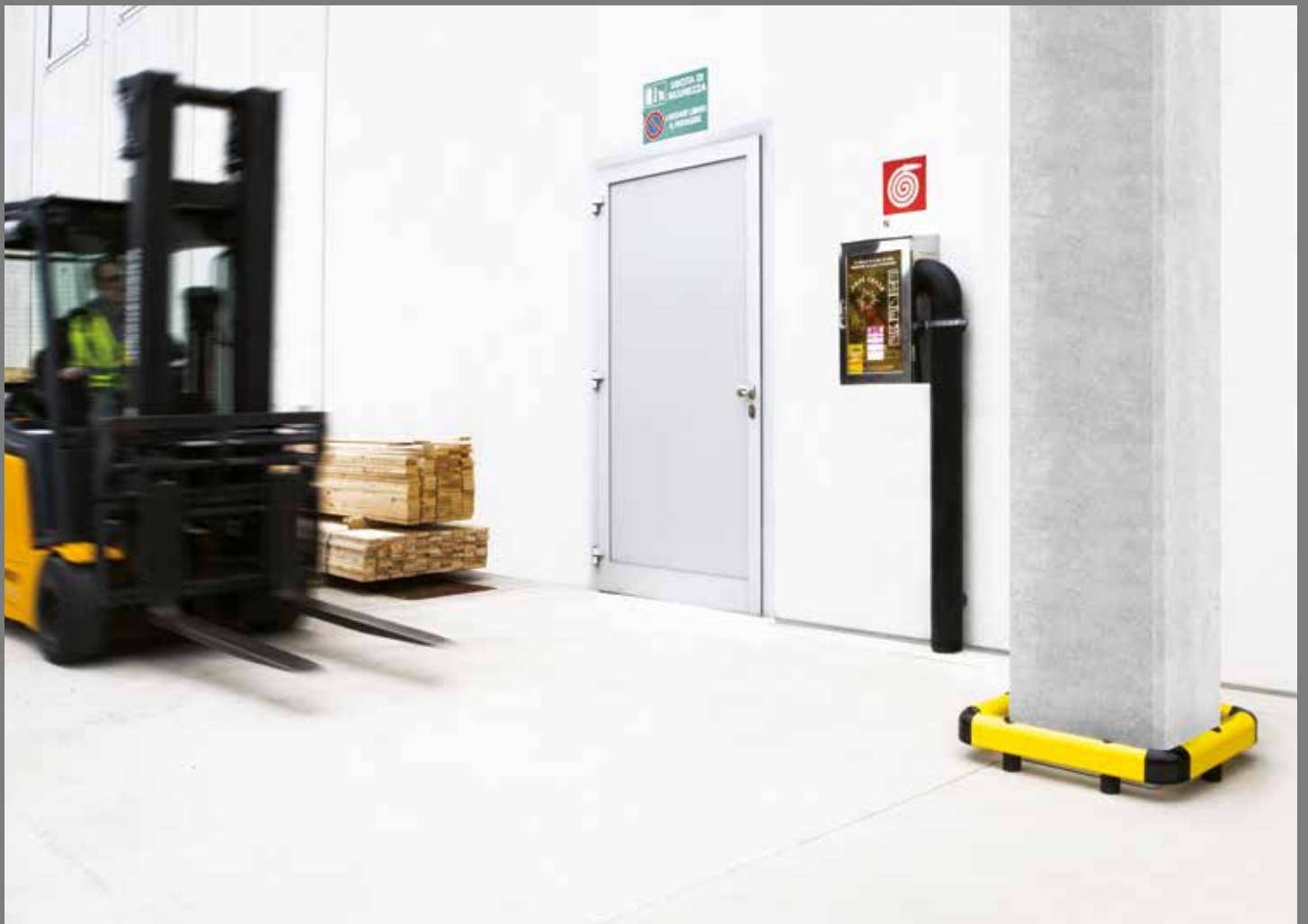

Sistema di profili specifico per la protezione delle colonne dai carrelli in movimento di varie portate. Progettato seguendo un innovativo disegno tecnico che coniuga rapidità e semplicità nella fasi di installazione e pulizia. Disponibile in diverse altezze e tipologie di fissaggio.

Nouveau système bumper, spécifique pour protéger les poutres contre les mouvements des chariots. Étudié avec un modern dessin qui regroupe la rapidité et la facilité pendant l'installation et le nettoyage. Disponible en différents hauteurs et différents fixations.

Sistema de perfiles específico para la protección de las columnas de los carros en movimiento de diferentes capacidades. Diseñado según un innovador diseño técnico que une velocidad y simplicidad en las fases de instalación y limpieza. Disponible en diferentes alturas y tipos de fijación.



- REMOVABLE
- NO SCRATCHES
- VERY SOLID AND SLIM DESIGN
- NOT FIXED TO THE COLUMN

Column protections

COLUMN PROTECTION 90



DIFFERENT SIZES ON REQUEST

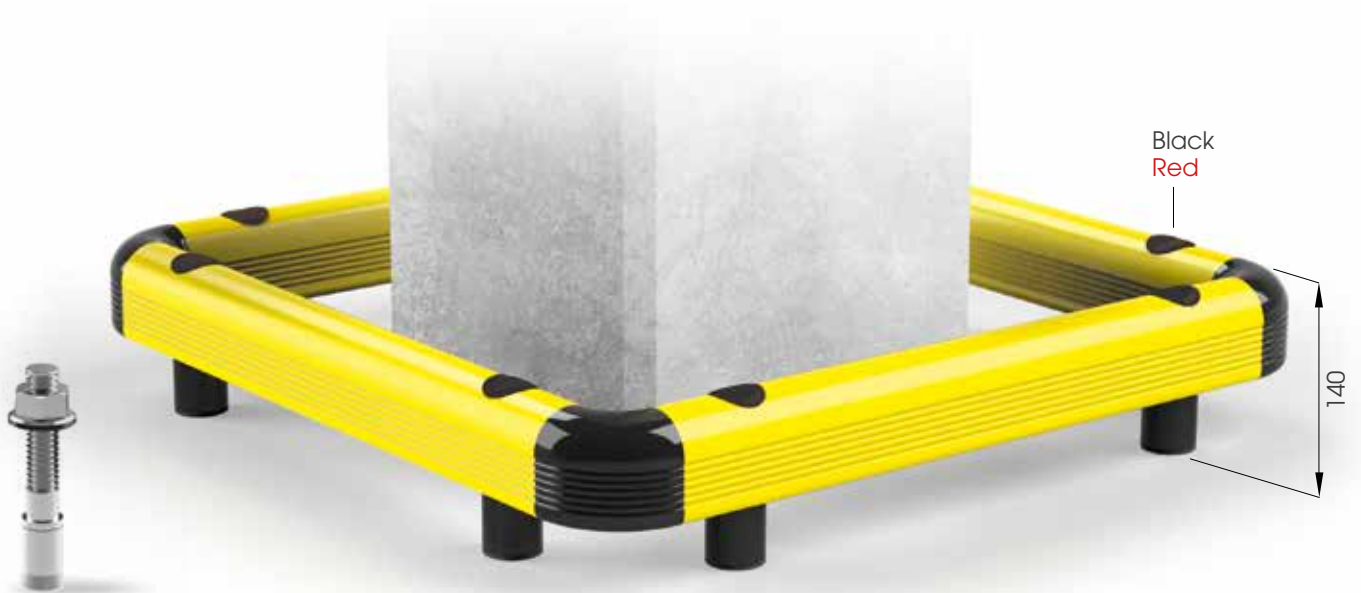

M16
STAINLESS STEEL



COPRO 90 500x500
600x600
700x700

Packing Colour **unpacked on pallet**
M

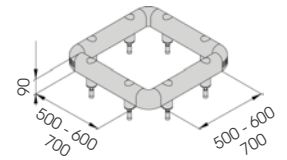

Equipped with accessories



COLUMN PROTECTION 150



DIFFERENT SIZES ON REQUEST



M20
STAINLESS STEEL



COPRO 150 500x500
600x600
700x700

Packing Colour **unpacked on pallet**
M

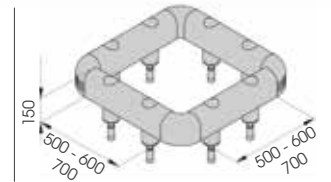

Equipped with accessories



Column protections

HUG TOWER



DIFFERENT
SIZED AND
HEIGHT ON
REQUEST

COMPACT

↑
**CHOOSE THE
HEIGHT YOU NEED!
UNTIL 5 RAILS**

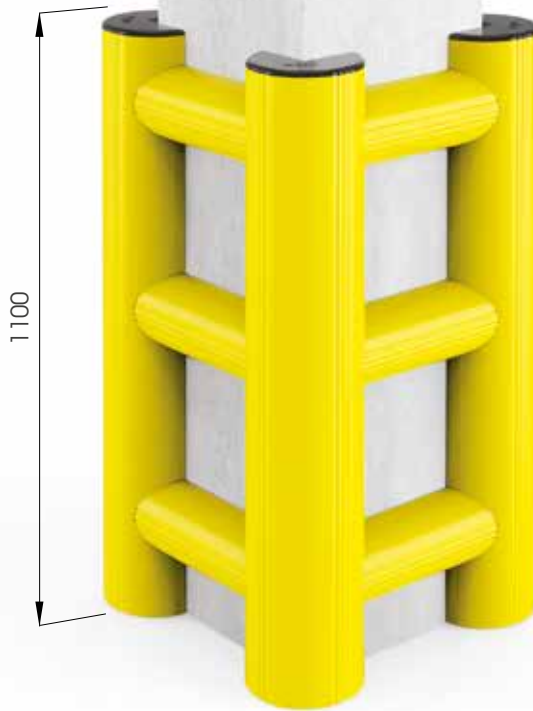

**NO HOLES
ON THE FLOOR AND COLUMN!**



**HUG TOWER 500x500
600x600
700x700**

Packing Colour **to be defined**
Colour **M**

Equipped with accessories

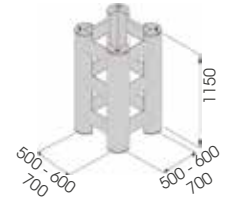

TOWER PROTECTION



DIFFERENT SIZES ON REQUEST



M12 GALVANISED STEEL



TOWER 500x500
600x600
700x700

Packing Colour to be defined



Equipped with accessories

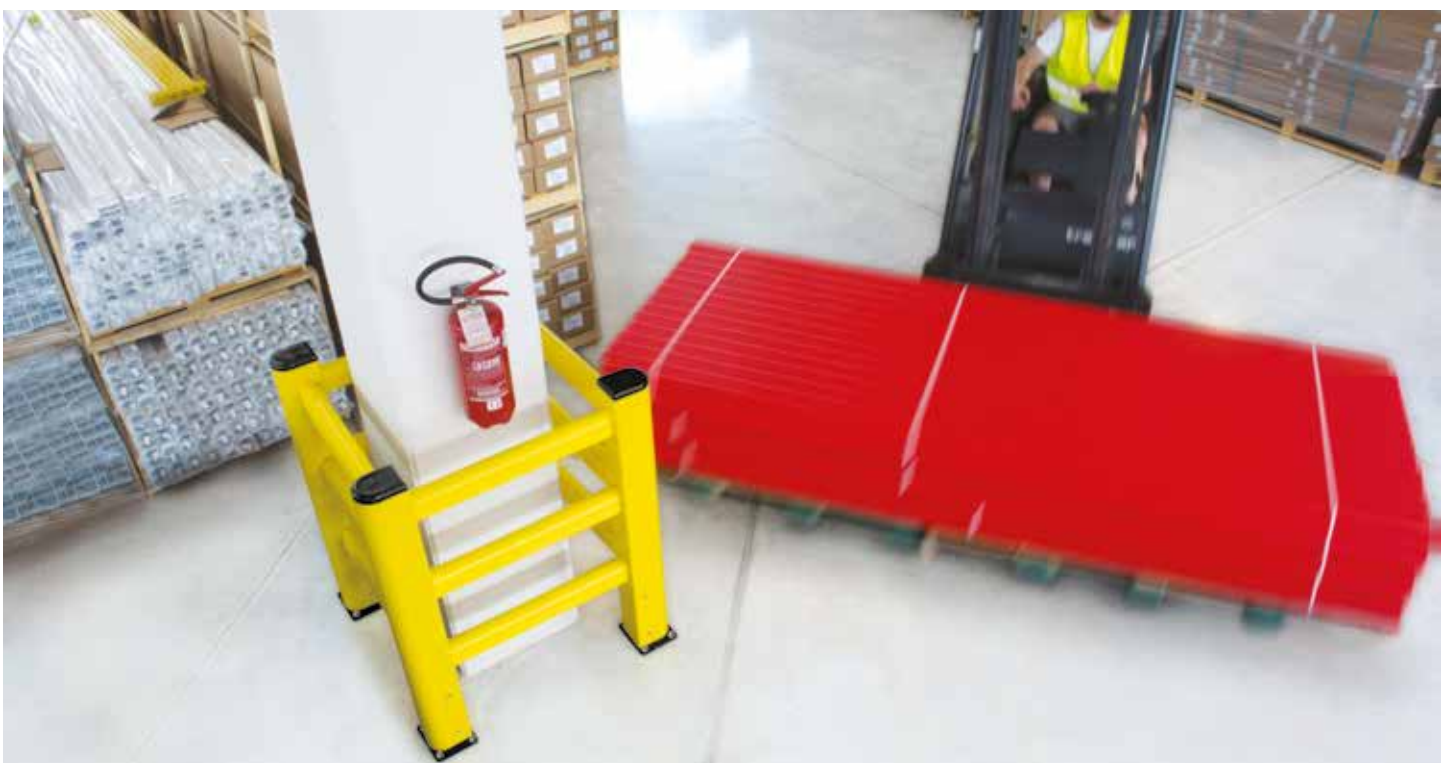
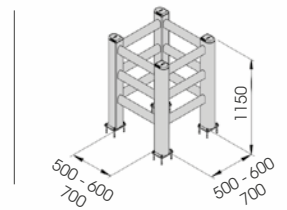

08

CORNER PROTECTIONS

Designed to protect pillars and columns or external corners of walls and panels.

Realizzato per proteggere pilastri e colonne o angoli esterni di muri e pannelli.

Étudié pour protéger les poteaux et les colonnes ou les angles extérieurs de murs et de panneaux.

Realizado para proteger pilares y columnas o esquinas exteriores de paredes y paneles.



Corner Protections



CP 100

Length **4.000 mm**
 Packing **10 pz / box**
 Colour **B M E F**

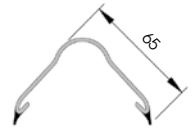

CPF 100

Length **4.000 mm**
 Packing **10 pz / bag**



CPT 100

Packing **40 pz / box**
 Colour **B E F**

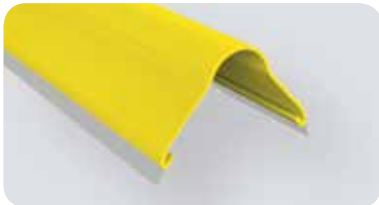
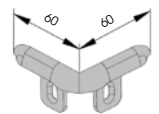

CP 200

Length **4.000 mm**
 Packing **2 pz / bag**
 Colour **B M E**



Length **2.000 mm**
 Packing **2 pz / bag**
 Colour **M**



CPF 200

Length **2.000 / 4.000 mm**
 Packing **2 pz / bag**



CPT 200

Packing **20 pz box**
 Colour **B E**

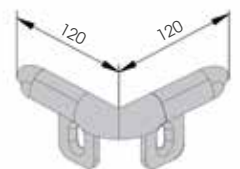

09

KERB

A large size protection system, ideal for walls and panels. Easy to install and clean. Fully equipped with corner caps and buttons.

To install with Channels CH and CU

Monta con canale CH e CU

À installer avec les U de sol CH et CU

Montaje con canal CH y CU



Sistema di protezione di grandi dimensioni,
ideale per muri e pannelli. Facile da installare e pulire
Completo di angolari e tappi.

Système de protection
de grands dimensions, idéal
pour les murs et les panneaux.
Facile à installer et à nettoyer.
Complété de bouchons
d'angles et d'embouts.

Sistema de protección
de grande dimensión,
ideal para paredes
y paneles. Fácil de instalar
y limpiar. Completo de
esquinas y tapas.

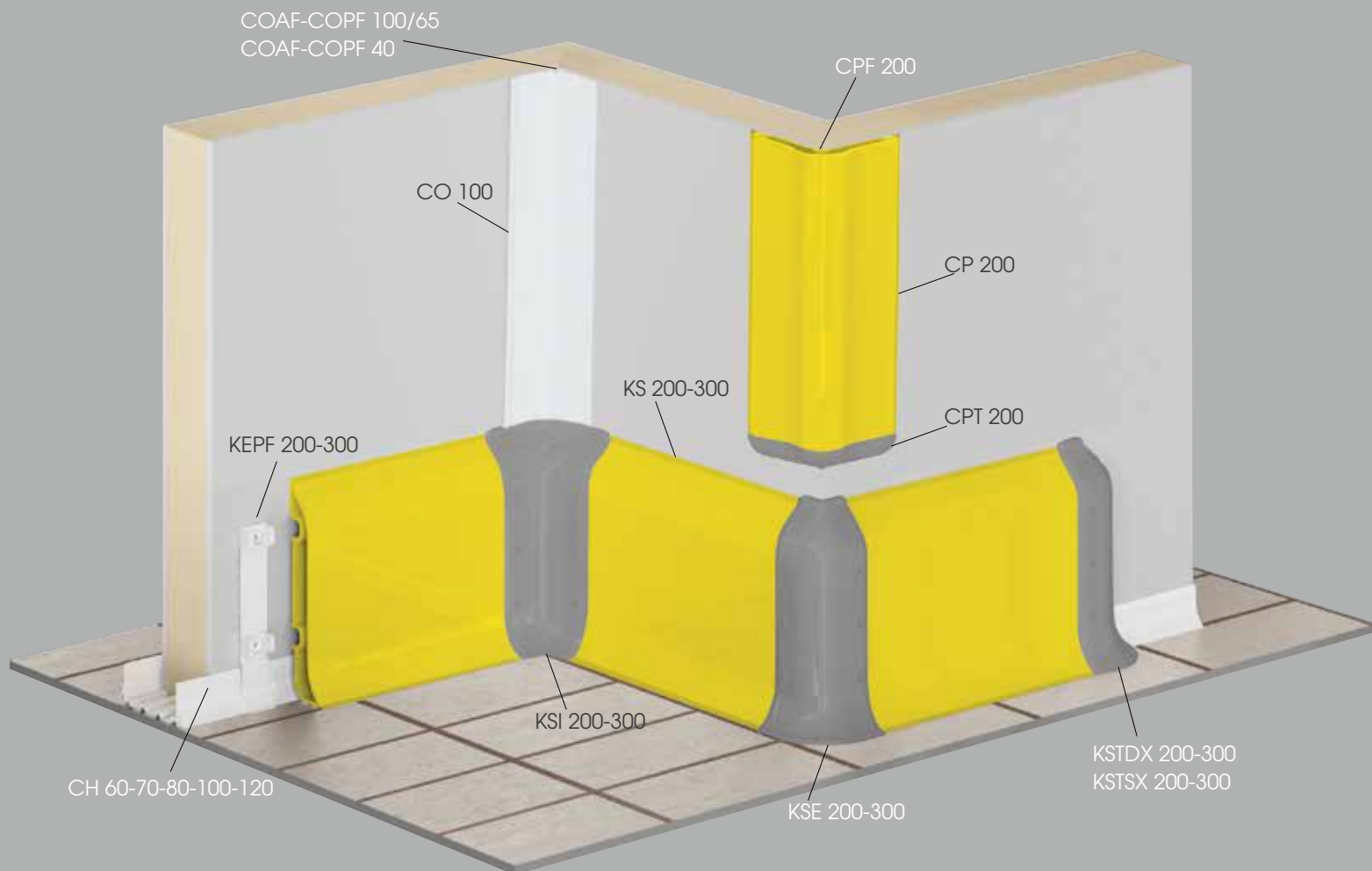

Kerb



KS 200

Length **4.000 mm**
 Packing **3 pz / box**
 Colour **B M E**

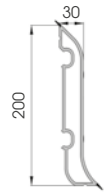

KEPF 200

To install with TB14

Packing **50 pz / box**
 Colour **K**

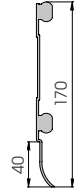

KSJ 200

To install with TB14 / TF14

Packing **20 pz / box**
 Colour **B E**

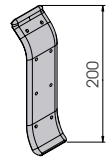

KSI 200

To install with TB14 / TF14

Packing **20 pz / box**
 Colour **B E**

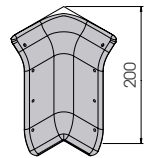

KSE 200

To install with TB14 / TF14

Packing **20 pz / box**
 Colour **B E**

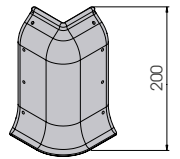

KSTD/SX 200

To install with TB14 / TF14

Packing **20 pz / box**
 Colour **B E**

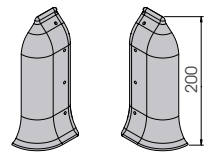

KSJ 200 LT



Packing **to be defined**
 Colour **K**

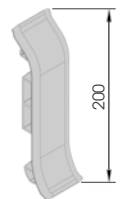

KS 300

Length **4.000 mm**
 Packing **1 pz**
 Colour **B M E**

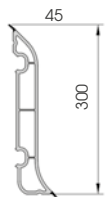

KEPF 300

To install with TB20

Packing **40 pz / box**

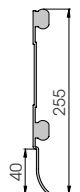



KSJ 300
To install with TB20 / TF20

Packing 10 pz / box
Colour B E

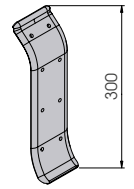

KSI 300
To install with TB20 / TF20

Packing 10 pz / box
Colour B E

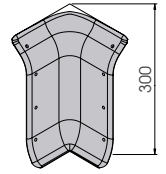

KSE 300
To install with TB20 / TF20

Packing 10 pz / box
Colour B E

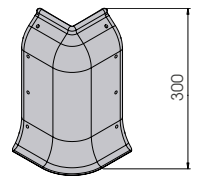

KSTD/SX 300
To install with TB20 / TF20

Packing 10 pz / box
Colour B E

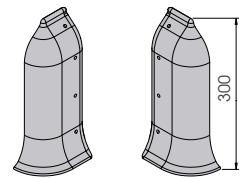

10

WALL BUMPERS

New bumper without guides.
Thanks to its big size and resistance it is
ideal for protection of industrial spaces.
Fixed caps with hidden screws covered
by specific buttons.

Nuovo profilo antiurto senza guida. La
sua ampiezza e resistenza lo rende
ideale per la protezione di ambienti
industriali. Terminali fissati con viti
nascoste da appositi bottoni.

Nouveau profilé anti-choc sans besoin
d'une base à fixer. Sa mesure large et sa
résistance en font le profilé parfait pour
la protection des espaces industriels.
Embouts fixés avec des vis cachées
grâce à des bouchons spécifiques.

Nuevo perfil antigolpe sin guía.
Su amplitud y resistencia lo hacen
ideal para la protección de entornos
industriales. Terminales fijados con
tornillos ocultos por botones especiales.



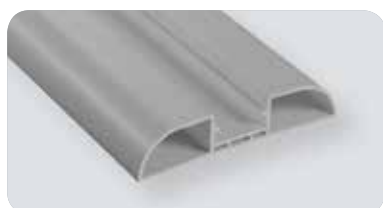
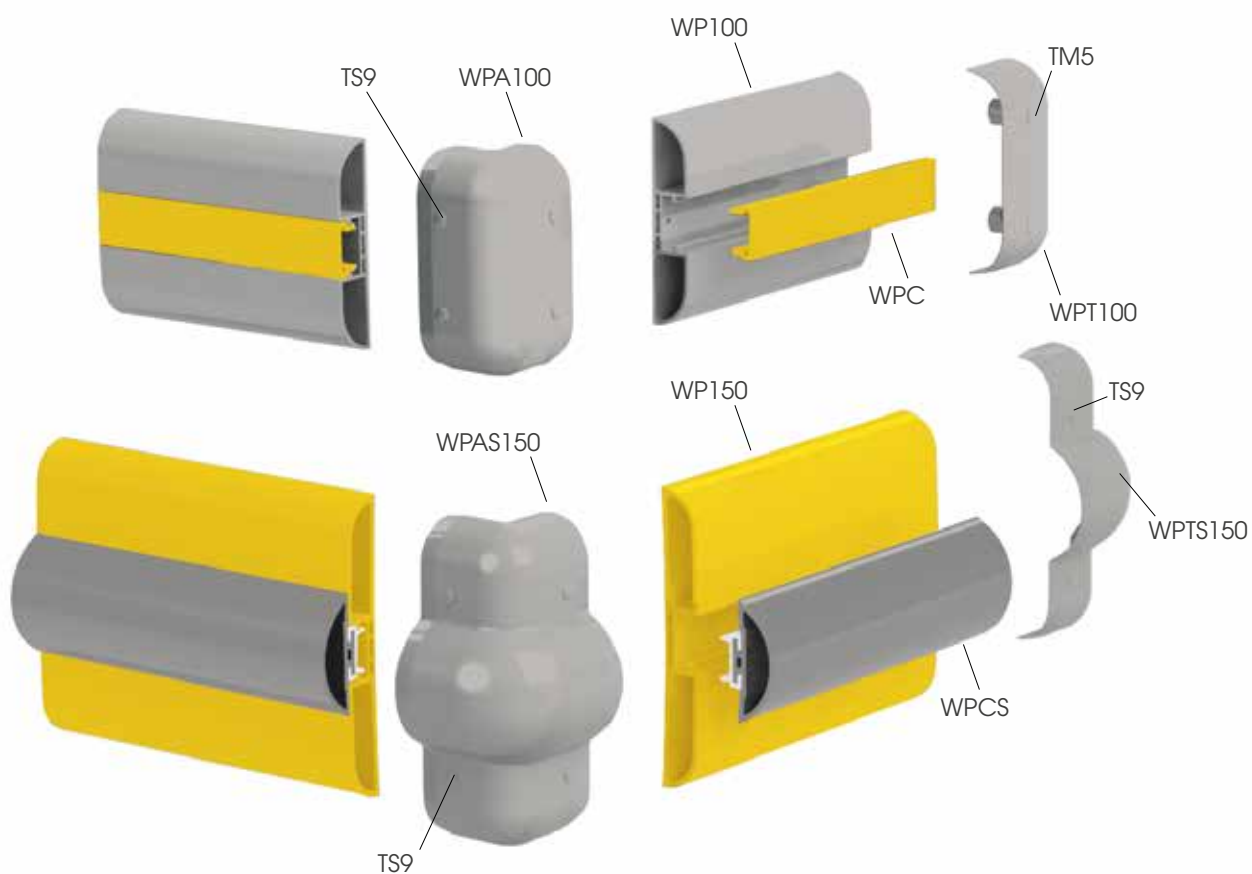

WP 100

Length **4.000 mm**
 Packing **8 pz / box**
 Colour **B E F**

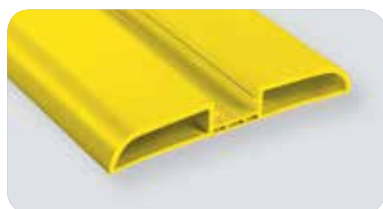
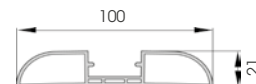

WP 150

Length **4.000 mm**
 Packing **4 pz / box**
 Colour **B M E**

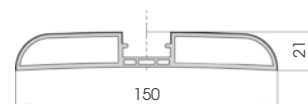

WPC

To install with WP 100 / WP 150

Length **4.000 mm**
 Packing **16 pz / box**
 Colour **A B M D E F G H**

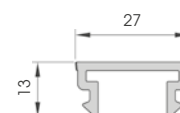

Wall Bumpers



WPT 100
To install with TM5

Packing 50 pz / box
Colour B E F

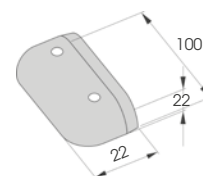

WPA 100
To install with TS9

Packing 20 pz / box
Colour B E

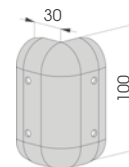

WPT 150
To install with TM5

Packing 50 pz / box
Colour B E

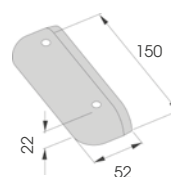

WPA 150
To install with TS9

Packing 20 pz / box
Colour B E

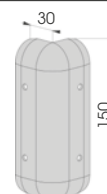

WPCS
To install with WP 100 / WP 150

Length 4.000 mm
Packing 8 pz / box
Colour A B M D E
F G H I



WPTS 100
To install with TS9

Packing 20 pz / box
Colour B E

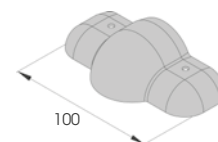

WPAS 100
To install with TS9

Packing 20 pz / box
Colour B E

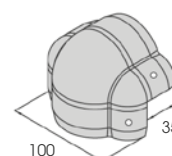

WPTS 150
To install with TS9

Packing 20 pz / box
Colour B E

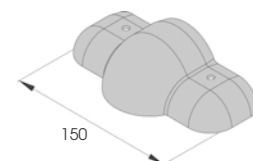

WPAS 150
To install with TS9

Packing 20 pz / box
Colour B E

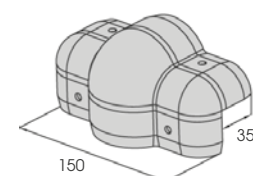

ALWAYS THE BEST PROTECTION PROFILES

CHOOSE THE BEST!



Wall Bumpers

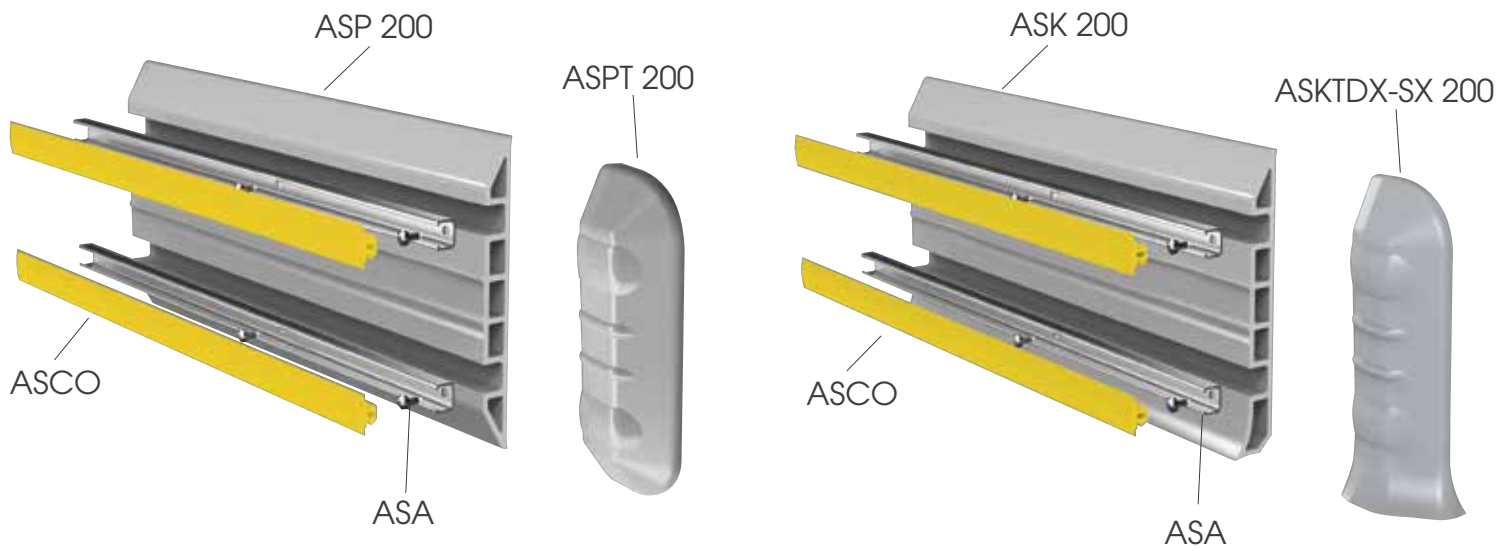



ASK 200



Length **4.000 mm**
 Packing **2 pz / box**
 Colour **B C**

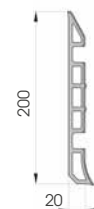

ASK2I200



Packing **to be defined**
 Colour **B**



ASK2E 200



Packing **to be defined**
 Colour **B**

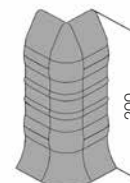

ASKTDX-SX 200



Packing **to be defined**
 Colour **B**



ASP 200



Length **4.000 mm**
 Packing **2 pz / box**
 Colour **B C**

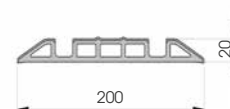

ASPT 200



Packing **10 pz / box**
 Colour **B D**

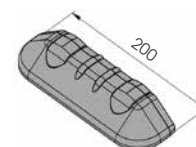

ASA

Material **aluminium**
 Length **4.000 mm**
 Packing **8 pz / bundle**

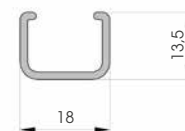

ASCO



Packing **2 pz / box**
 L = **32.000 mm**
 Colour **A B C D E**



11

PVC PANEL



PVC sheets to renovate fastly and cheaply the walls of cold rooms and cold store.

Lastre in PVC per il rinnovo rapido ed economico delle pareti nelle celle e nei magazzini frigoriferi.

Plaques en PVC pour renover rapidement et a bas prix les murs de chambres froides et de depots frigorifiques.

Placas de PVC para una renovación rápida y económica de paredes en celdas y cámaras frigoríficas.

DIFFERENT
SIZES ON
REQUEST



PF 300

Foamed inside

FOAMED
INSIDE

Length 3.000/4.000 mm
Packing 3 pz / bag
Colour White



PR 300

Length 3.000/4.000 mm
Packing 3 pz / bag
Colour White



PJ

To install with PR 300 and PF 300

Length 3.000 mm
Packing 10 pz / box
Colour White

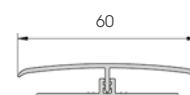

PA

To install with PR 300 and PF 300

Length 3.000 mm
Packing 10 pz / box
Colour White



PT

To install with PR 300 and PF 300

Length 3.000 mm
Packing 10 pz / box
Colour White

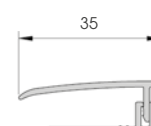



LOFT BARRIER

WORLD'S FIRST FIXED PROTECTION SYSTEM FOR SUSPENDED AREAS



FENCE LINK

THE ADAPTABLE STRONGEST SOLUTION FOR RACK-ENDS

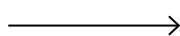

Now available
CUSTOMISED RACK PROTECTOR,
new version of rack protector
processed upon request!

CUSTOMISED RACK PROTECTOR



TM5
Hole required \varnothing 8.5
Neutral polyethylene. 100/500 Pcs. / bag.



TS9
Hole required \varnothing 5
White or grey nylon. 1000 Pcs. / bag.



TB14
Hole required \varnothing 4
Steel / aluminium, white. 500 Pcs. / box.



TF14
Hole required \varnothing 5
Aluminium. 500 Pcs. / box.



TB20
Hole required \varnothing 5
Steel / aluminium. 500 Pcs. / box.



TF20
Hole required \varnothing 6.5
Aluminium. 500 Pcs. / box.



M12
HILTI ANCHOR BOLT
Hole required \varnothing 12
Galvanized steel. 25 Pcs. / box.



S12
HILTI ANCHOR BOLT
Hole required \varnothing 12
Galvanized steel. 20 Pcs. / box.



B12
HILTI INSERT
Hole required \varnothing 18
Galvanized steel. 10 Pcs. / box.



B16
HILTI INSERT
Hole required \varnothing 22
Galvanized steel. 10 Pcs. / box.



B20
HILTI INSERT
Hole required \varnothing 28
Galvanized steel. 10 Pcs. / box.



FR
HILTI CHEMICAL ANCHOR
300 ML

Colours

A	B	D	E	F	G	H	I	K	L	M
RED RAL 3002	GREY RAL 7040	BLACK RAL 9005	WHITE RAL 9010	WHITE RAL 9002	BLUE RAL 5005	GREEN RAL 6029	SILVER RAL 9006	LIGHT GREY RAL 7035	DARK GREY RAL 7024	LIGHT YELLOW RAL 1018

Cleaner resistant	Cheap	Easy to clean	YES NO
Quick assembly	Long resistance	Good thermal insulation	
Shockproof	Good waterproof	Non toxic	Class V0 self-extinguishing fire resistance

MPM srl reserves the right, at any time, to introduce the necessary changes and improvements to its products. Any small imperfection in the products and in the materials used are due to the processing method. Any reproduction of this brochure, even in part, is forbidden.



THE WORLD'S TOP **LOGISTICS**
PROFESSIONALS CHOOSE OUR
QUALITY MADE IN ITALY





SOME OF OUR REFERENCES



ALESSI



amazon

AURICCHIO

B/S/H/



Coca-Cola
Refreshments



NOVARTIS



FCA
FIAT CHRYSLER AUTOMOBILES



GARNIER



LEROYMERLIN

MAINA



Electrolux



Colgate



OUR INSTALLATION



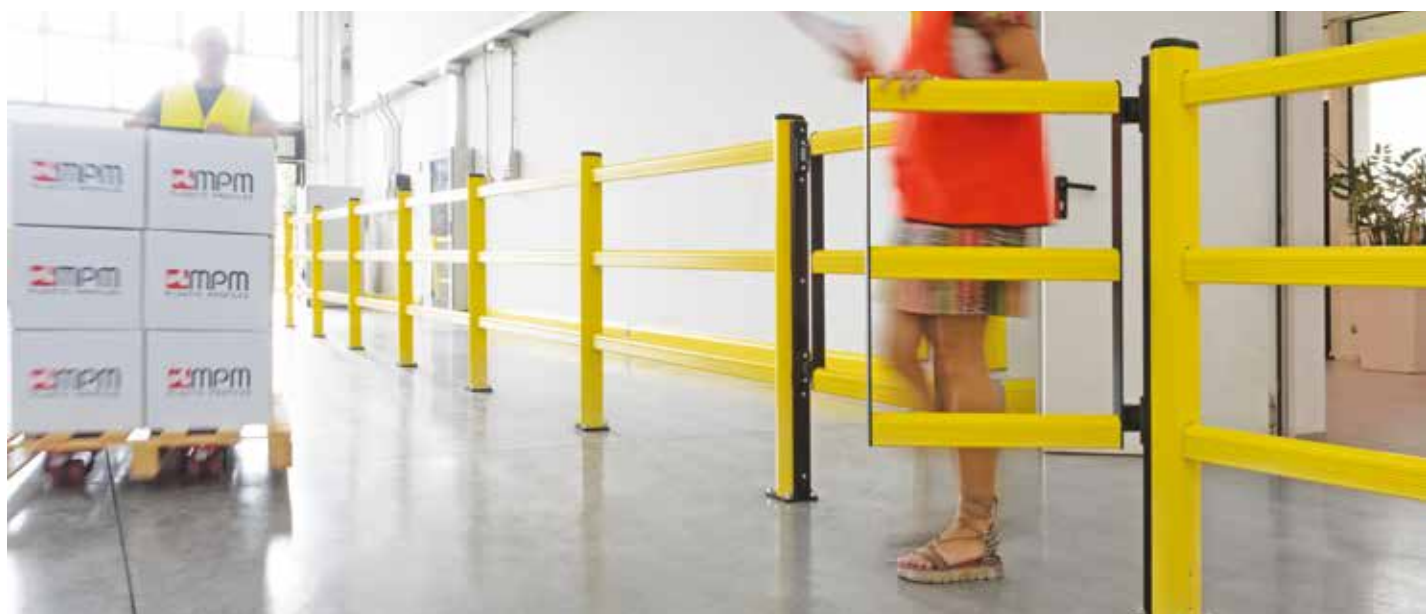

EXCLUSIVE **AIRPORT LINE**



FLY HIGH WITH OUR PROTECTIONS

ALWAYS RESISTANT / ALWAYS FLEXIBLE



**CONTACT US FOR
FURTHER DETAILS!**



MPM states that:

The safety coefficient and consequent use of the product requires preliminary screening by a designer who will necessarily have to take account of the actual installation conditions, considering that instructions contained in catalogues, orders, transport documents, invoices or any other documentation showing the product characteristics, should not be considered suitable to compensate for any lack of design or technical testing required for installation of the product.

In any case, it is necessary to comply with the appropriate assembling and installation instructions as defined in the technical catalogue on corporate websites (www.mpmpvc.com). MPM will accept no liability for the use of profiles in situations that have not been preceded by the above-mentioned checks.

Impact forces indicated in the brochure, or in other documents, refer to laboratory tests and cannot take account for consequences determined by installation modes or peculiarities of the place where the products are installed (in an operational environment vehicle type, speed and mass, routes, angles of impact, ground and anchorage are variable and uncontrolled conditions that no test can replicate); the data refers to an intact product that can be affected by alterations from incorrect maintenance and old age, as well as the methods and characteristics of installation (with specific reference to floor-mounted products like the latter); the weight, dimensions, colours and characteristics of the material refer to the sample and the conformity with the latter of the product supplied will be subject to normal production tolerance. The product may be affected by environmental installation conditions.

Protections performances can be affected in environments with temperatures below 0°C or higher than 50°C.

The fastness of the colour and its brightness depend on wear and tear and climatic conditions that can affect its intensity over time.

Images in the brochure are for advertising purposes only and do not in any way represent how the products should be used.

Full version of MPM product warranty available in the technical catalogue on corporate websites (www.mpmpvc.com).



MADE IN ITALY



mpm
PLASTIC PROTECTIONS



Systems Design

storage equipment & materials handling

T +44 01892 256007

info@systemsdesignuk.com

www.systemsdesignuk.com